

# MOBILE COMPACTOR SYSTEM

## - HAND PUSH

*Eloquently Maximizing Large Workspaces*

## Eloquently Maximizing Large Workspaces

Specially made for file organization and space efficiency, Mobile Compactor maximizes the storage capacity of your current space, creates more "people" space, and helps you focus on your important tasks.

### INTRODUCTION

The nearly unlimited storage solutions Mobile Compactor offers will address your specific storage needs.



#### FEATURES



Strong & Slick Steel Handle



Adjustable Foot Cap



Smooth Anti-tilt

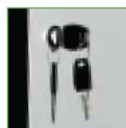

Central Locking System

#### IDEAL FOR:

- Office Supplies
- Medical Supplies
- Backroom Inventory
- Sporting Goods
- Law Books
- Media
- Parts
- Tools

#### OTHER ADVANTAGES

Mobile Compactor	Adjustable Foot Cap	Adjustable Side
Other Mobile Compactors	Wall Plug	Metal Plate

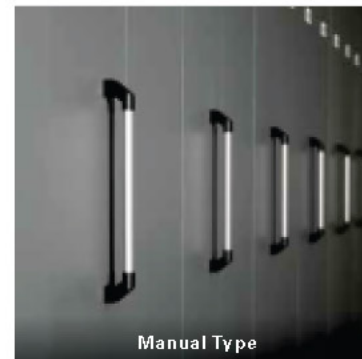

Manual Type

- Platform with adjustable foot caps (no drilling or pre-leveling on the floor is needed)
- Foot cap height adjusts up to 30mm
- Rails are made of 3mm cold rolled steel using laser cut process
- Pre-treatment process which includes deionized water rinse, followed by electrostatic polyester-epoxy powder coating as standard finish
- Industrial wheels – quiet & strong
- Standard in track anti-tilt mechanism

TYPES	SPECIFICATIONS
MATERIAL	Cold Rolled Steel
FINISH	Epoxy Powder Coating
SHELF SIZE	910(W) x 355(D) x 25(H)
WIDTH	980
HEIGHT	2150
NO. OF SHELF	4 pieces per bay
LOADING PER SHELF	40kg UDL
AISLE SIZE	800mm
ANTI TILT MECHANISM	Nylon Guide D40mm
MATERIAL THICKNESS	Base : 1mm, Back Panel : 0.6mm, Rail : 3mm, Platform : 18mm Chipboard, Top Panel : 0.8mm, Side Panel : 0.8mm, Shelf : 0.6mm
RAIL	Made of 3mm Cold Rolled Steel Using Laser Cut Process and with Adjustable Foot Cap
WHEEL	D60mm Bearing with Nylon Coating, Loading : 150kg/ Wheel
MOVEMENT	Left/ Right

### TECHNICAL INFORMATIONS

#### STANDARD BAY TYPES

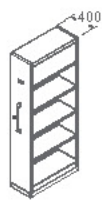

Single Bay With Lock (BAY A)

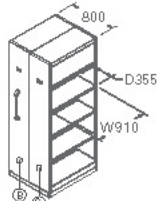

Double bay (BAY B & C)

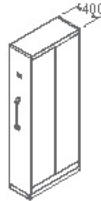

Single bay (BAY B)

#### BAY DEEP AND LOAD

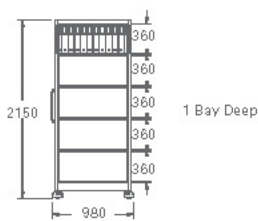

1 Bay Deep

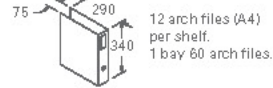

12 arch files (A4) per shelf.  
1 bay 60 arch files.

#### BAY CONFIGURATIONS

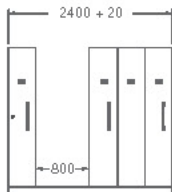

4 BAY

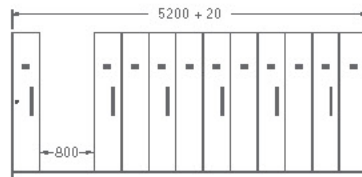

11 BAY

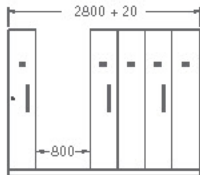

5 BAY

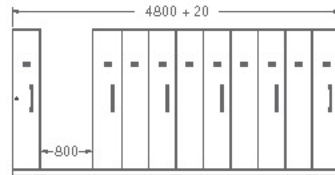

10 BAY

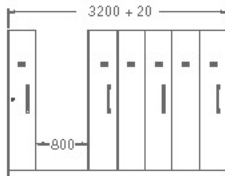

6 BAY

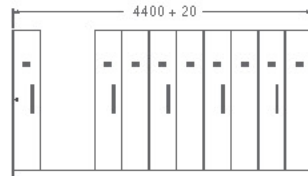

9 BAY

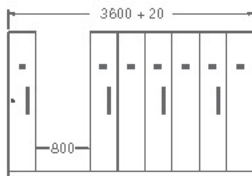

7 BAY

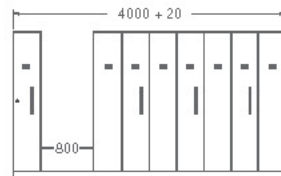

8 BAY

#### ACCESSORIES



STOCK

DESC : SHELF  
DIMENSION : 910(W) X 355(D) X 25(H)  
PACKING DIM : 930 X 375 X 40  
WEIGHT / VOL : 2.2 KG / 0.01 M<sup>3</sup>



STOCK

DESC : LATERAL FRAME  
DIMENSION : 840(W) X 355(D) X 79(H)  
PACKING DIM : 860 X 375 X 90  
WEIGHT / VOL : 5 KG / 0.03 M<sup>3</sup>



STOCK

DESC : DRAWER  
DIMENSION : 840(W) X 355(D) X 150(H)  
PACKING DIM : 860 X 375 X 160  
WEIGHT / VOL : 6 KG / 0.05 M<sup>3</sup>



STOCK

DESC : SWING DOOR  
DIMENSION : 840(W) X 18(D) X 1895(H)  
PACKING DIM : 60 X 450 X 1930  
WEIGHT / VOL : 15 KG / 0.05 M<sup>3</sup>



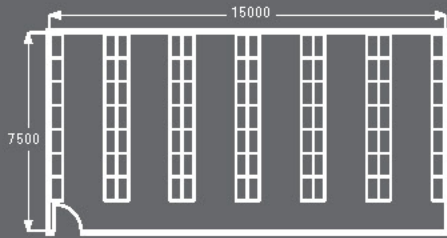

228%

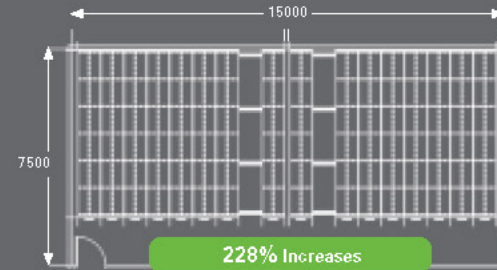

**228 percent of usage space with 100 percent efficiency!**

Optimise your space without expensive remoulding. Because only the access aisle is necessary for sliding shelves, room capacity can be more than doubled in comparison to stationary shelving.

**Your Advantages at a Glance:**

- Optimal surface-use increases storage capacity to 228%
- Faster and easier access to archive material
- Easy operation with all movable versions:
  - manual, with sliding shelf handle
  - mechanical, with handwheel or automatic rotary reel

# MOBILE COMPACTOR SYSTEM - MECHANICAL

*Eloquently Maximizing Large Workspaces*

## LINING PLATFORM

### Design to Perfection

Thanks to our all-encompassing, extensive market research, we build the mobile compactors tailored to 21st century needs.

Our key strengths are:

- i. Platform with adjustable foot caps (no drilling or pre-leveling on the floor is needed)
- ii. Easy setup, assembling, leveling, and disassembly

## INTRODUCTION

Our mechanical wheel type mobile compactor is designed using different gear ratio so that the cabinet can be moved by generally turning the handwheel. This design minimizes the power to move a large object. Besides, gears and roller chains have been tested for the firmness. This is the reason why we can vouch that our mobile compactor can move much smoother and quieter.



FEATURES



Safety Lock



Adjustable Foot Cap



Smooth Anti-tilt



Central Lock

### IDEAL FOR:

- Office Supplies
- Medical Supplies
- Backroom Inventory
- Sporting Goods
- Law Books
- Media
- Parts
- Tools

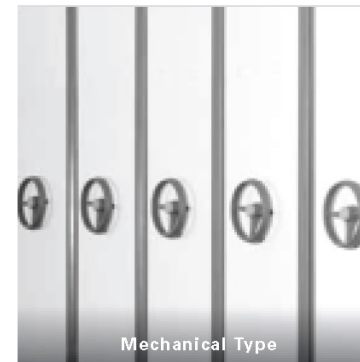
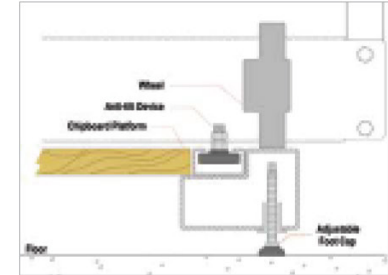
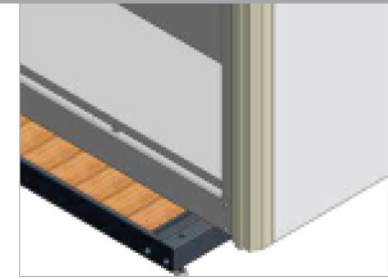
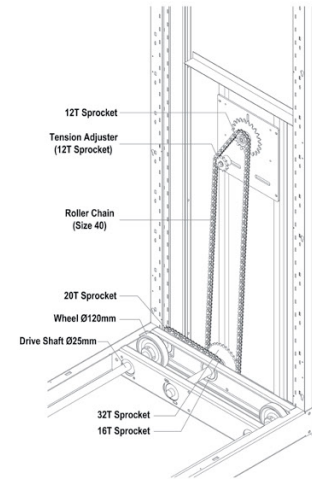

Mechanical Type

- Platform with adjustable foot caps (no drilling or pre-leveling on the floor is needed)
- Foot cap height adjusts up to 30mm
- Rails are made of 3mm cold rolled steel using laser cut process
- Pretreatment process including deionized water rinse followed by electrostatic polyester-epoxy powder coating as standard finish
- Industrial wheels - quiet & strong
- Standard in track anti-tilt mechanism
- The built-in safety locks for mechanical type cabinets are designed to safeguard users from being accidentally trapped in aisles
- Heavy duty iron die casting wheels with anti-rust zinc coating
- Close type front panel that avoids dust
- Central lock system

TYPES	SPECIFICATIONS
MATERIAL	Cold Rolled Steel
FINISH	Epoxy Powder Coating
SHELF SIZE	897(W) x 361(D) x 25(H)
NO. OF SHELF	4 pieces per bay
LOADING PER SHELF	70kg UDL
AISLE SIZE	780/ 800mm
MATERIAL THICKNESS	Back Panel : 0.7mm, Shelf : 0.7mm, Side Panel : 0.7mm, Base Frame : 2mm, Post : 1.5mm, Top Panel : 1.0mm, Front Panel : 0.8/ 1.0mm
RAIL WITH PLATFORM	Rail : 3mm Cold Rolled Steel with Laser Cut Process/ Complete with Adjustable Foot Cap, Platform : 18mm Chipboard
POST	C-Channel Post with Slots in 25mm increment
ANTI TILT MECHANISM	Nylon Guide D40mm
WHEEL	Iron Die Casting with Anti-rust Zinc Coating, Loading : 1000kg/ Wheel

TECHNICAL INFORMATIONS

STANDARD BAY TYPES

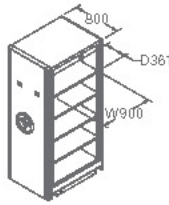

Double bay



Double bay with lock

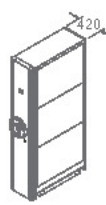

Single bay with lock

BAY LOAD

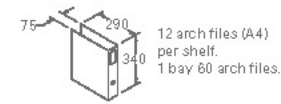
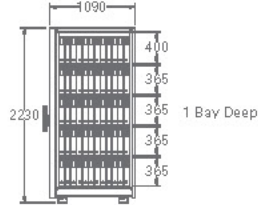

BAY CONFIGURATIONS

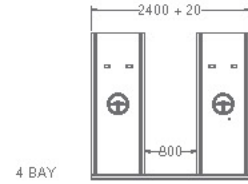

4 BAY

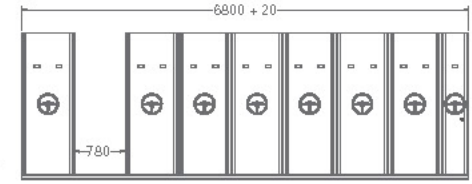

15 BAY

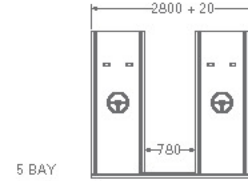

5 BAY

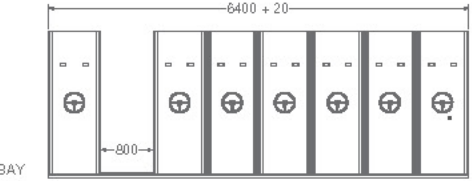

14 BAY

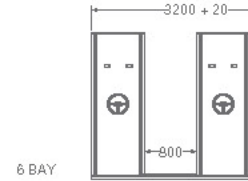

6 BAY

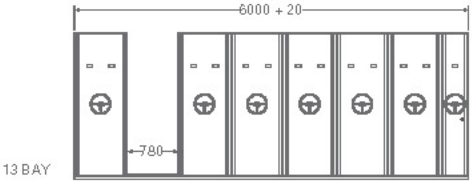

13 BAY

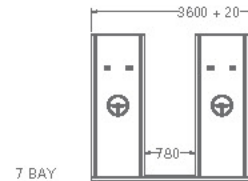

7 BAY

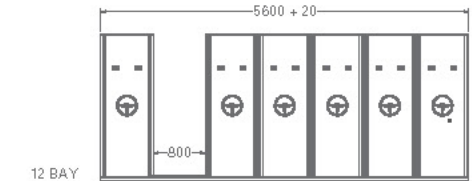

12 BAY

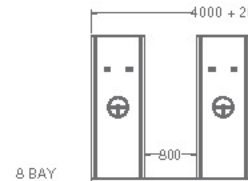

8 BAY

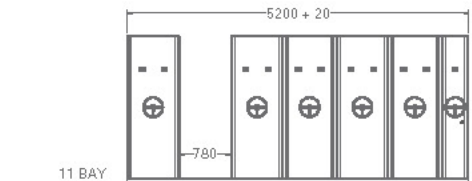

11 BAY

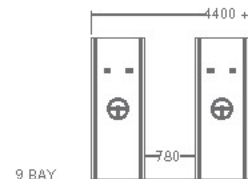

9 BAY

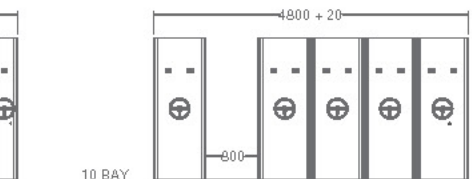

10 BAY

BAY DEEP CONFIGURATIONS



1 BAY DEEP

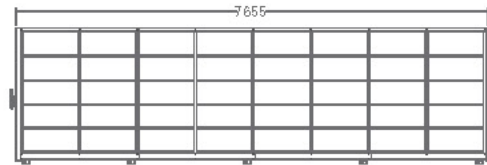

8 BAY DEEP



2 BAY DEEP

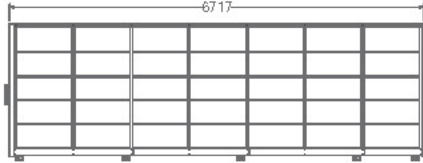

7 BAY DEEP

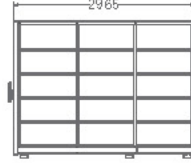

3 BAY DEEP

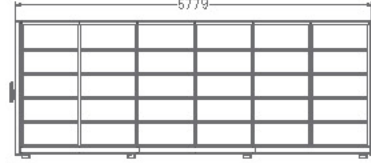

6 BAY DEEP

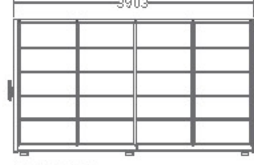

4 BAY DEEP

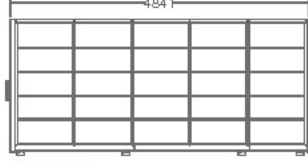

5 BAY DEEP