



MDCUM
Trade name of Metal Designs & Concepts Limited.

KASS PARTITION & WORKSTATION SYSTEMS
SHOP NOW



www.mdc-um.com



KASS PARTITION & WORKSTATION SYSTEMS

Welcome to the Future of Workspace Solutions

MDC-UM's Kass Partition & Workstation systems offer modern, customizable, and efficient office solutions that reflect your company's values while enhancing productivity.

Key Features

Customization

Tailor partitions and worksurfaces by width, height, color and material (fabric or laminate) to match your office aesthetics.

Modern Design

Enjoy a clean, organized workspace with a modular design that allows for easy expansion and reconfiguration.

Sustainability

Made from recyclable materials, promoting a greener workplace.

Proven Choice

A trusted office system in the Caribbean, known for quality and reliability.

Our Office Systems provide the versatility needed for any office setup, helping your team thrive!

Discover the Kass Difference and transform your workspace today!



Single Seater

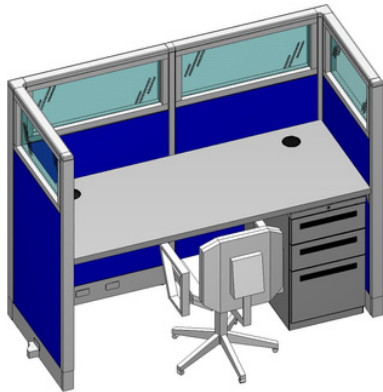

STRAIGHT DESK WITH GLASS PANELS



L SHAPED DESK WITH SOLID PANELS

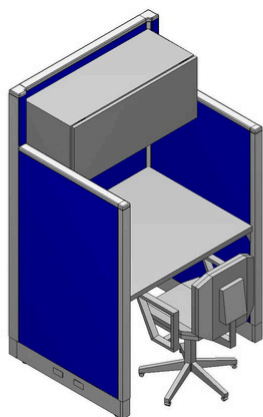

SMALL STRAIGHT DESK WITH METAL OVERHEAD STORAGE BIN

2-Seater

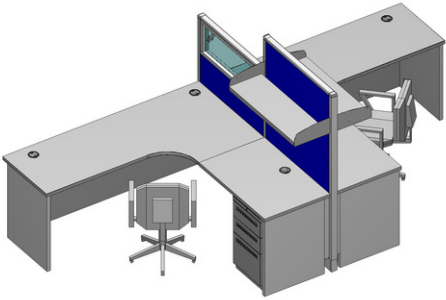

**L SHAPED DESKS WITH KASS PARTITIONS
FEATURING SHELVING AND GLASS**

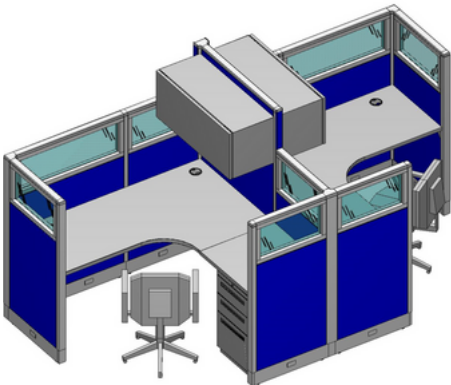

**L SHAPED DESKS - KASS PARTITION WITH
GLASS AND OVERHEAD STORAGE BINS**



**STRAIGHT DESKS WITH HIGH PARTITIONS
FEATURING OVERHEAD STORAGE BINS**

2-Seater



**L SHAPED DESKS WITH T SHAPED
PANELS- SOLID & GLASS**

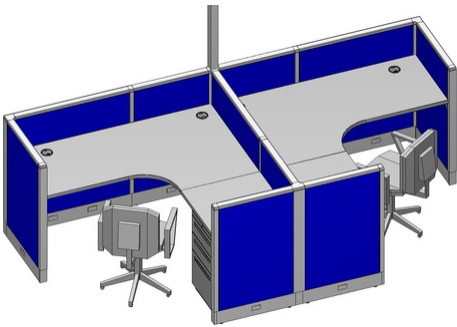

**L SHAPED DESKS WITH POWERED POLE
AND SOLID PANELS**

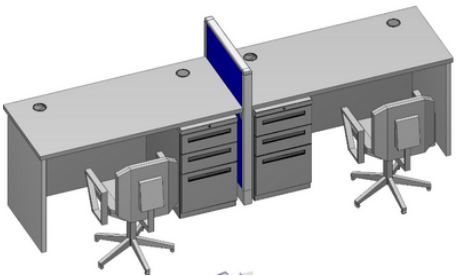

**STRAIGHT DESKS WITH SINGULAR
PANEL PARTITION**

2-Seater



**L SHAPED DESKS WITH T SHAPED
PANELS- SOLID & GLASS**



**STRAIGHT DESKS SIDE BY SIDE W/
SOLID PANELS**

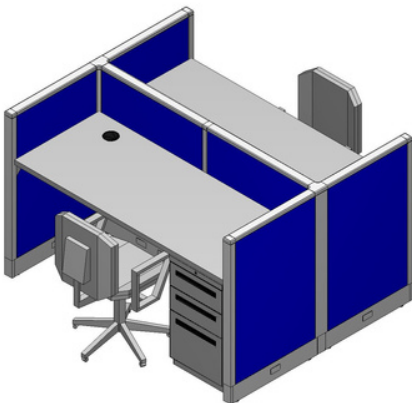

**2 STRAIGHT DESKS: OPPOSITES W/
SOLID PANEL PARTITIONS**

2-Seater

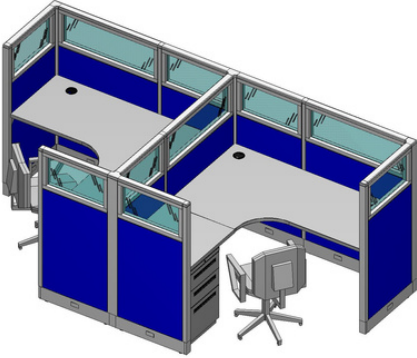

**L SHAPED DESKS WITH T SHAPED
PANELS- SOLID & GLASS**



**STRAIGHT DESKS WITH T SHAPED
PANELS W/ EXTENDED SOLID &
GLASS PANELS**

MODULAR , EXPANDABLE, CUSTOMISABLE, RECYCLABLE

3- Seater

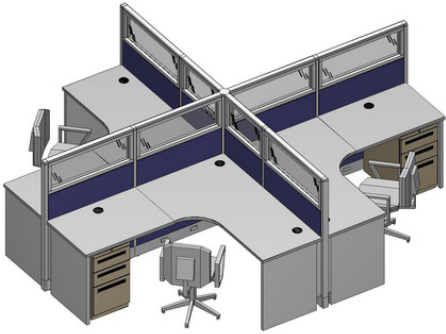

**L SHAPED DESKS : X PANELS WITH GLASS
- AREA FOR PRINTER/STATION/STORAGE**

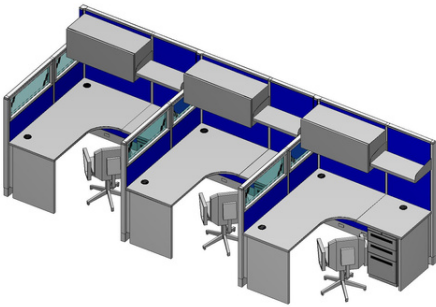

**LINE SHAPED SYSTEM - PANELS WITH
OVERHEAD BINS AND SHELVING &
PANELS WITH GLASS**

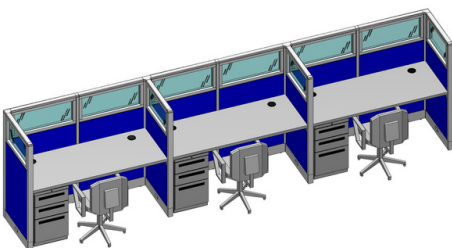

STRAIGHT DESKS WITH GLASS PANELS

4-Seater

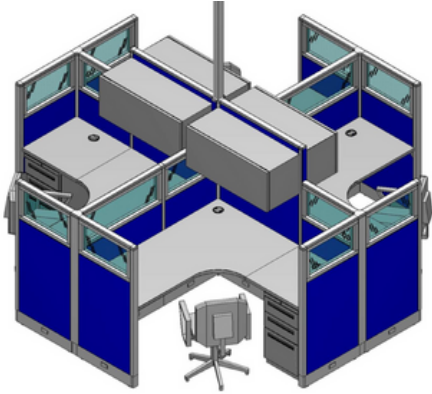

**L SHAPED DESKS WITH X SHAPED PANELS,
POWERED POLE AND OVERHEAD STORAGE
BINS**

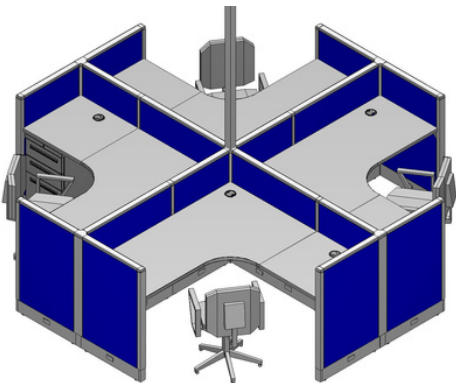

**L SHAPED DESKS WITH X SHAPED PANELS
AND POWERED POLE**

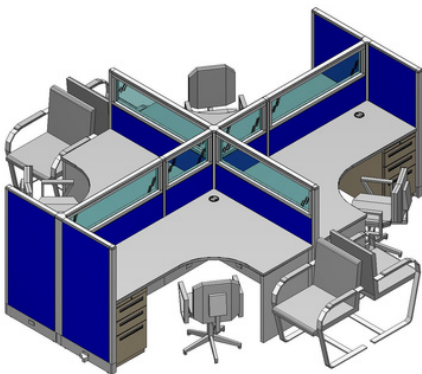

**L SHAPED DESKS: X SHAPED GLASS
PANELS WITH GUEST AREA**

4-Seater

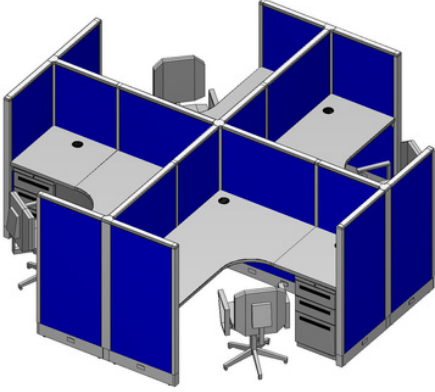

L SHAPED DESKS: X SHAPED W/ SOLID PANELS

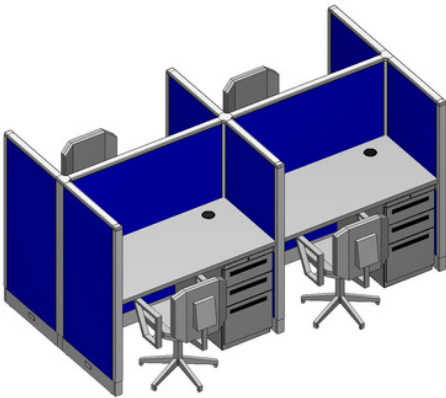

**4 STRAIGHT DESKS -OPPOSITES- W/
SOLID PANELS**

CUBICLE STYLE

**TRANSFORM YOUR WORKSPACE EFFORTLESSLY WITH OUR
VERSATILE KASS & WORKSTATION SYSTEM.**

DESIGNED TO BE STYLED IN COUNTLESS WAYS TO SUIT
ANY NUMBER OF STAFF MEMBERS, ENSURING A COHESIVE
AND DYNAMIC ENVIRONMENT FOR YOUR ENTIRE TEAM.

Customizable- 5-Seater+

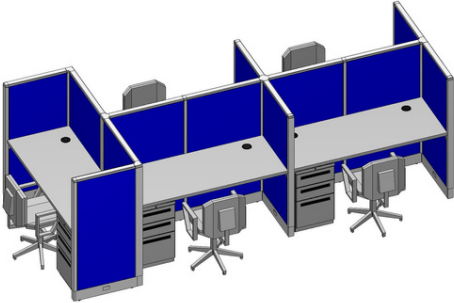

STRAIGHT DESKS - 5 SEATER



L SHAPED DESKS- 6 SEATER

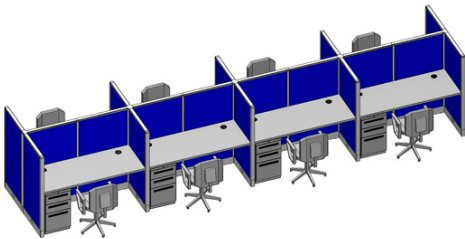

CUBICLES



Customizable - Styles

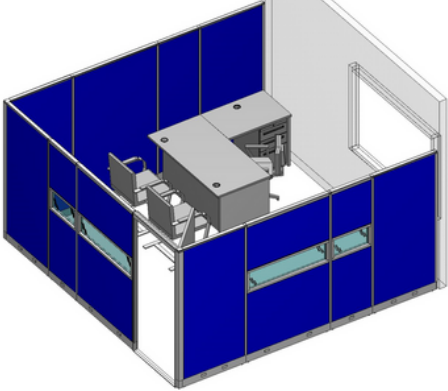

OFFICE STYLE
MANAGERIAL/SUPERVISORY STYLE

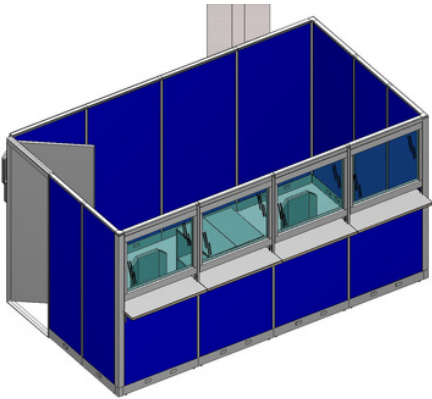

CSR STYLE

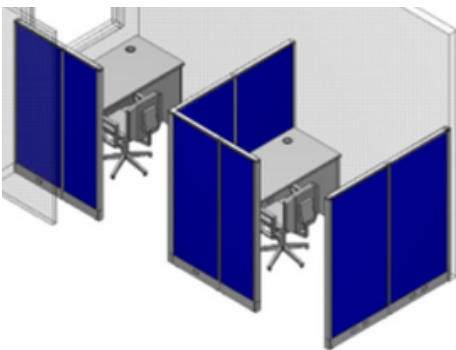

PRIVACY STYLE

Customizable - Styles



U SHAPED STYLE

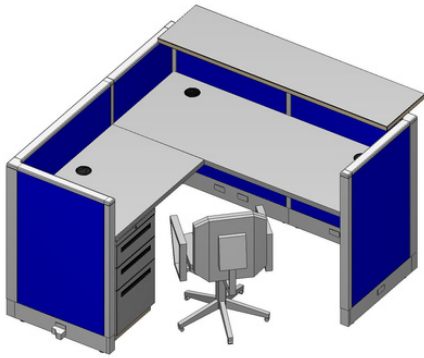

RECEPTION STYLE

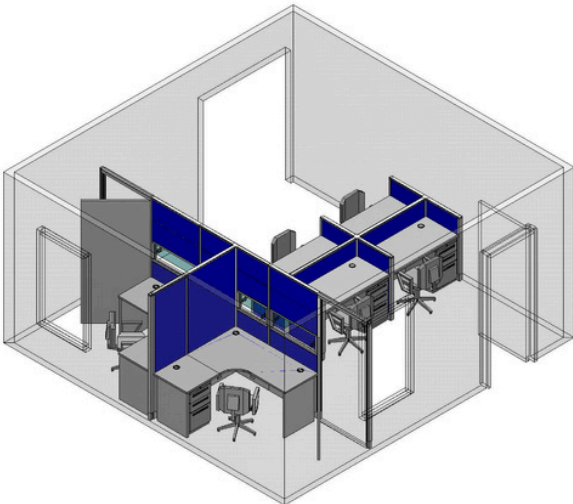

COMBINE AND TAILOR MANY DIFFERENT STYLES FOR YOUR SPECIFIC FLOOR PLAN!

Customization- Panels

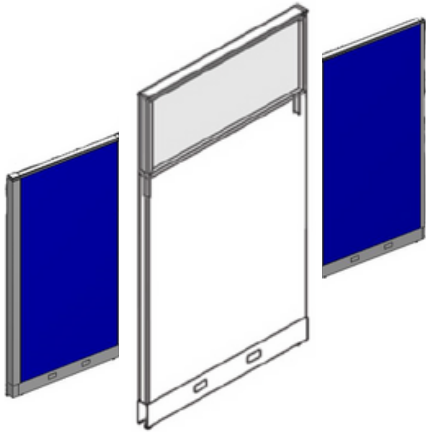

SOLID PANELS

- Standard Heights - 43" H , 56" H , 82" H
- Standard Widths- 18" , 24" , 30" , 36" , 42" , 48"
- Acoustic
- All Metal to Metal Connections
- Base mounted cable management
- Adjustable Glides
- Customizable- Changable combination
- Punch-outs for data/ Electrical
- Available in Fabric or Laminate Skins

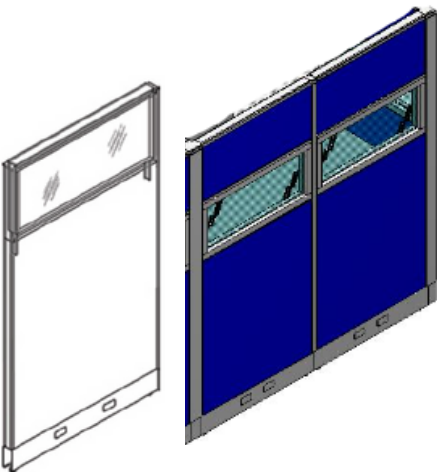

SOLID PANELS WITH GLASS

- Standard Heights - 43" H , 56" H , 82" H
- Standard Widths- 18" , 24" , 30" , 36" , 42" , 48"
- Glass inserts are 12" or 24" situated at top / middle of panels
- Glass can be customized: Tinted or Frosted
- Framed Glass panels available
- Acoustic
- All Metal to Metal Connections
- Base mounted cable management
- Adjustable Glides
- Customizable Panels- Changable combination
- Punch-outs for data/ Electrical
- Available in Fabric or Laminate Skins

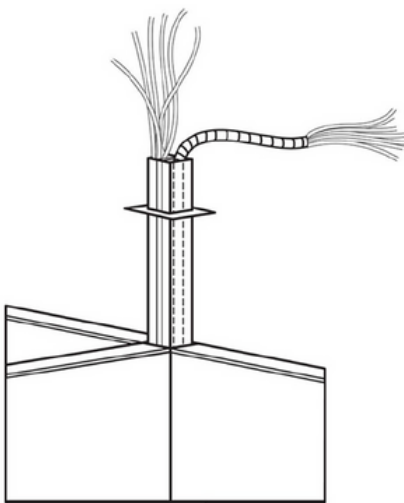

ELECTRICAL & DATA CAPACITY

- All Frames feature base plate electrical access and routing
- Worksurfaces are all available with wire management grommets.
- Powered grommets are also available.
- Wire access can be optioned for ceiling, side or ground feed in points
- Available UL Listed Modular Electrical System (Byrne)
- Compatible with Cat5E & Cat6 Bend radii
- Lay in cable capability at base
- Up to 12 pairs of telephony cable allows large work clusters

Customization-Accessories

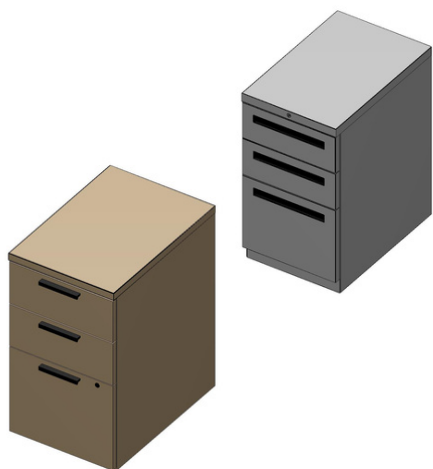

**MOBILE PEDESTALS-
METAL / LAMINATED**

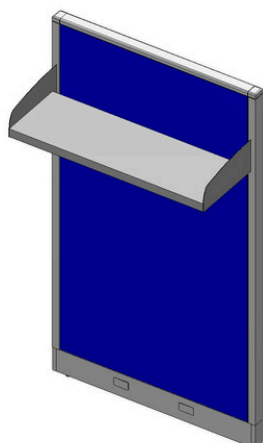

OVERHEAD SHELVES

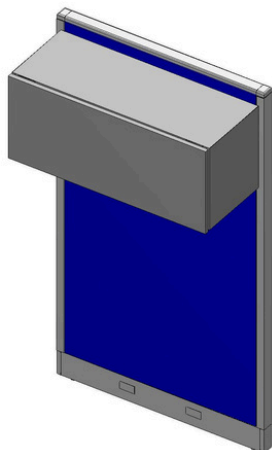

METAL OVERHEAD STORAGE BINS

Customization-Accessories



CPU BIN



KEYBOARD TRAYS



LAMINATED DOORS

Customization-Accessories



MONITOR ARMS



**ACRYLIC DIVIDERS:
CLEAR OR FROSTED**



**GROMMETS:
POWERED / OR WIRE GROMMETS**

LET US KNOW WHICH ADD-ON SUITS YOU BEST!

Our Satisfied Clients



Delivered and Installed with Ease and Expertise!

Our Satisfied Clients

- MASSY STORES
- AMERICAN AIRLINES
- FOSTER WHEELER
- SAGICOR FINANCIAL
- ANSA GROUP- TATIL LIFE
- WORLEY PARSONS
- HADCO LTD.
- TRINIDAD AND TOBAGO BUREAU OF STANDARDS
- MINISTRY OF WORKS & TRANSPORT
- COSTAATT
- MINISTRY OF PUBLIC ADMINISTRATION
- G.C HOLDINGS LIMITED
- ISLAND FINANCE
- NALIS
- DIRECT TV
- FLOW
- MINISTRY OF AGRICULTURE
- POWERGEN
- TOBAGO REGIONAL HEALTH AUTHORITY (TRHA)
- GLOBAL FINANCIAL
- T&TEC
- TSTT
- WASA
- HDC
- UWI
- TTMA
- PENTA PAINTS
- CARIBBEAN AIRLINES LTD
- UNIT TRUST (TRINIDAD)
- UNIVERSITY OF TRINIDAD AND TOBAGO
- NATIONAL ENERGY SKILLS CENTRE (NESC)
- COLFIRE
- TRINIDAD AND TOBAGO HOSPITALITY INSTITUTE
- CIPRIANI LABOUR COLLEGE
- IBC EXPRESS LIMITED
- RENTOKIL
- PETROTRIN
- TRINIMAR
- PHOENIX PARK GAS PROCESSORS LIMITED
- MINISTRY OF LEGAL AFFAIRS
- MINISTRY OF EDUCATION
- TUCKER ENERGY SERVICES LIMITED
- NIBTT
- MINISTRY OF PUBLIC UTILITIES
- ASSOCIATED BRANDS LTD
- MINISTRY OF FINANCE
- SUPERPHARM
- FAB CREATORS
- PHOENIX WELDING AND FABRICATING LTD
- BLUEBERRY INVESTMENTS
- ANSA

WE SERVE CLIENTS INTERNATIONALLY TOO!

AND MUCH MORE!